

# MC 1,5/ 2-ST-3,81 - PCB connector



1803578

<https://www.phoenixcontact.com/in/products/1803578>

Please be informed that the data shown in this PDF document is generated from our online catalog. Please find the complete data in the user documentation. Our general terms of use for downloads are valid.



PCB connector, nominal cross section: 1.5 mm<sup>2</sup>, color: green, nominal current: 8 A, rated voltage (III/2): 160 V, contact surface: Tin, contact connection type: Socket, number of potentials: 2, number of rows: 1, number of positions: 2, number of connections: 2, product range: MC 1,5/..-ST, pitch: 3.81 mm, connection method: Screw connection with tension sleeve, screw head form: L Slotted, conductor/PCB connection direction: 0 °, plug-in system: COMBICON MC 1,5, locking: without, mounting: without, type of packaging: packed in cardboard

## Your advantages

- Well-known connection principle allows worldwide use
- Low temperature rise, thanks to maximum contact force
- Allows connection of two conductors

## Commercial data

Item number	1803578
Packing unit	250 pc
Minimum order quantity	250 pc
Sales key	AAB
Product key	AABABA
Catalog page	Page 190 (C-1-2013)
GTIN	4017918045883
Weight per piece (including packing)	1.546 g
Weight per piece (excluding packing)	1.5 g
Customs tariff number	85366990
Country of origin	IN

# MC 1,5/ 2-ST-3,81 - PCB connector



1803578

<https://www.phoenixcontact.com/in/products/1803578>

## Technical data

### Product properties

Type	Standard
Product line	COMBICON Connectors S
Product type	PCB connector
Product family	MC 1,5/...-ST
Number of positions	2
Pitch	3.81 mm
Number of connections	2
Number of rows	1
Mounting flange	without
Number of potentials	2

### Electrical properties

Nominal current $I_N$	8 A
Nominal voltage $U_N$	160 V
Degree of pollution	3
Contact resistance	1.3 m $\Omega$
Rated voltage (III/3)	160 V
Rated surge voltage (III/3)	2.5 kV
Rated voltage (III/2)	160 V
Rated surge voltage (III/2)	2.5 kV
Rated voltage (II/2)	320 V
Rated surge voltage (II/2)	2.5 kV

### Connection data

#### Connection technology

Type	Standard
Connector system	COMBICON MC 1,5
Nominal cross section	1.5 mm <sup>2</sup>
Contact connection type	Socket

#### Interlock

Locking type	without
Mounting flange	without

#### Conductor connection

Connection method	Screw connection with tension sleeve
Conductor/PCB connection direction	0 °
Conductor cross section rigid	0.14 mm <sup>2</sup> ... 1.5 mm <sup>2</sup>
Conductor cross section flexible	0.14 mm <sup>2</sup> ... 1.5 mm <sup>2</sup>
Conductor cross section AWG	28 ... 16
Conductor cross section flexible, with ferrule without plastic	0.25 mm <sup>2</sup> ... 1.5 mm <sup>2</sup>

# MC 1,5/ 2-ST-3,81 - PCB connector

1803578

<https://www.phoenixcontact.com/in/products/1803578>

sleeve	
Conductor cross section, flexible, with ferrule, with plastic sleeve	0.25 mm <sup>2</sup> ... 0.75 mm <sup>2</sup>
2 conductors with same cross section, solid	0.08 mm <sup>2</sup> ... 0.5 mm <sup>2</sup>
2 conductors with same cross section, flexible	0.08 mm <sup>2</sup> ... 0.75 mm <sup>2</sup>
2 conductors with same cross section, flexible, with ferrule without plastic sleeve	0.25 mm <sup>2</sup> ... 0.34 mm <sup>2</sup>
2 conductors with the same cross section, flexible, with TWIN ferrule with plastic sleeve	0.5 mm <sup>2</sup> ... 0.5 mm <sup>2</sup>
Cylindrical gauge a x b / diameter	2.4 mm x 1.5 mm / 1.6 mm
Stripping length	7 mm
Tightening torque	0.22 Nm ... 0.25 Nm

## Material specifications

### Material data - contact

Note	WEEE/RoHS-compliant, free of whiskers according to IEC 60068-2-82/JEDEC JESD 201
Contact material	Cu alloy
Surface characteristics	hot-dip tin-plated
Metal surface terminal point (top layer)	Tin (4 - 8 µm Sn)
Metal surface contact area (top layer)	Tin (4 - 8 µm Sn)

### Material data - housing

Color (Housing)	green (6021)
Insulating material	PA
Insulating material group	I
CTI according to IEC 60112	600
Flammability rating according to UL 94	V0
Glow wire flammability index GWFI according to EN 60695-2-12	850
Glow wire ignition temperature GWIT according to EN 60695-2-13	775
Temperature for the ball pressure test according to EN 60695-10-2	125 °C

## Dimensions

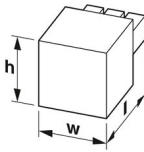
Dimensional drawing	
Pitch	3.81 mm
Width [w]	8.41 mm
Height [h]	11.1 mm
Length [l]	16.1 mm

## Mounting

# MC 1,5/ 2-ST-3,81 - PCB connector



1803578

<https://www.phoenixcontact.com/in/products/1803578>

Drive form screw head	Slotted (L)
Connection method	Screw connection with tension sleeve
Drive form screw head	Slotted (L)

## Mechanical tests

### Test for conductor damage and slackening

Specification	IEC 60999-1:1999-11
Result	Test passed

### Pull-out test

Specification	IEC 60999-1:1999-11
Conductor cross section/conductor type/tractive force setpoint/actual value	0.14 mm <sup>2</sup> / solid / > 7 N
	0.14 mm <sup>2</sup> / flexible / > 7 N
	1.5 mm <sup>2</sup> / solid / > 40 N
	1.5 mm <sup>2</sup> / flexible / > 40 N

### Insertion and withdrawal forces

Result	Test passed
No. of cycles	25
Insertion strength per pos. approx.	6 N
Withdraw strength per pos. approx.	4 N

### Torque test

Specification	IEC 60999-1:1999-11
---------------	---------------------

### Resistance of inscriptions

Specification	IEC 60068-2-70:1995-12
Result	Test passed

### Polarization and coding

Specification	IEC 60512-13-5:2006-02
Result	Test passed

### Visual inspection

Specification	IEC 60512-1-1:2002-02
Result	Test passed

### Dimension check

Specification	IEC 60512-1-2:2002-02
Result	Test passed

## Environmental and real-life conditions

### Vibration test

Specification	IEC 60068-2-6:2007-12
Frequency	10 - 150 - 10 Hz
Sweep speed	1 octave/min

# MC 1,5/ 2-ST-3,81 - PCB connector



1803578

<https://www.phoenixcontact.com/in/products/1803578>

Amplitude	0.35 mm (10 Hz ... 60.1 Hz)
Sweep speed	5g (60.1 Hz ... 150 Hz)
Test duration per axis	2.5 h

## Durability test

Specification	IEC 60512-9-1:2010-03
Impulse withstand voltage at sea level	2.95 kV
Contact resistance $R_1$	1.3 m $\Omega$
Contact resistance $R_2$	1.5 m $\Omega$
Insertion/withdrawal cycles	25
Insulation resistance, neighboring positions	> 5 M $\Omega$

## Climatic test

Specification	ISO 6988:1985-02
Corrosive stress	0.2 dm <sup>3</sup> SO <sub>2</sub> on 300 dm <sup>3</sup> /40 °C/1 cycle
Thermal stress	100 °C/168 h
Power-frequency withstand voltage	1.39 kV

## Ambient conditions

Ambient temperature (operation)	-40 °C ... 100 °C (dependent on the derating curve)
Ambient temperature (storage/transport)	-40 °C ... 70 °C
Relative humidity (storage/transport)	30 % ... 70 %
Ambient temperature (assembly)	-5 °C ... 100 °C

## Electrical tests

### Thermal test | Test group C

Specification	IEC 60512-5-1:2002-02
Tested number of positions	20

### Insulation resistance

Specification	IEC 60512-3-1:2002-02
Insulation resistance, neighboring positions	> 5 M $\Omega$

### Air clearances and creepage distances |

Specification	IEC 60664-1:2007-04
Insulating material group	I
Comparative tracking index (IEC 60112)	CTI 600
Rated insulation voltage (III/3)	160 V
Rated surge voltage (III/3)	2.5 kV
minimum clearance value - non-homogenous field (III/3)	1.5 mm
minimum creepage distance (III/3)	2 mm
Note on connection cross section	With connected conductor 1.5 mm <sup>2</sup> (solid).
Rated insulation voltage (III/2)	160 V
Rated surge voltage (III/2)	2.5 kV
minimum clearance value - non-homogenous field (III/2)	1.5 mm
minimum creepage distance (III/2)	1.5 mm

# MC 1,5/ 2-ST-3,81 - PCB connector



1803578

<https://www.phoenixcontact.com/in/products/1803578>

Rated insulation voltage (II/2)	320 V
Rated surge voltage (II/2)	2.5 kV
minimum clearance value - non-homogenous field (II/2)	1.5 mm
minimum creepage distance (II/2)	1.6 mm

## Packaging specifications

Type of packaging	packed in cardboard
-------------------	---------------------

# MC 1,5/ 2-ST-3,81 - PCB connector



1803578

<https://www.phoenixcontact.com/in/products/1803578>

## Drawings

Diagram

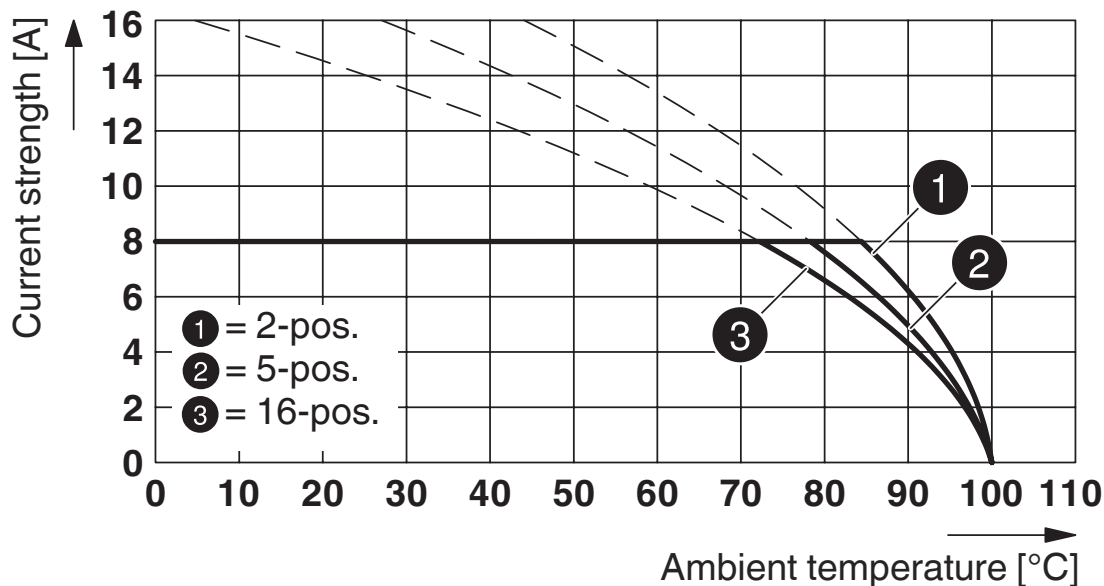

Type: MC 1,5/...-ST-3,81 with IMC 1,5/...-ST-3,81

Diagram

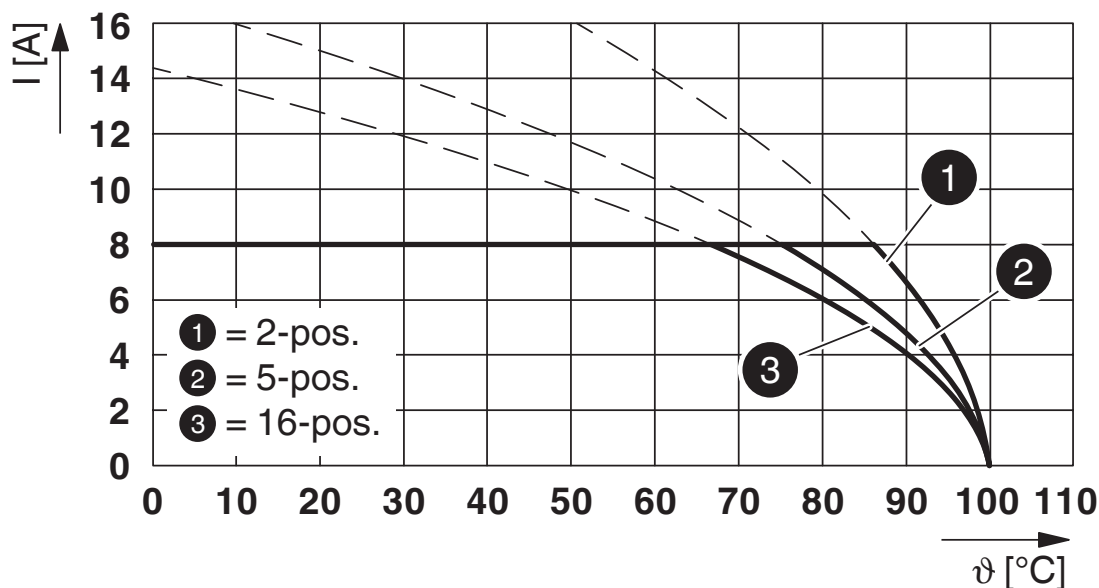

Type: MC 1,5/...-ST-3,81 with MCDV 1,5/...-G-3,81

# MC 1,5/ 2-ST-3,81 - PCB connector

1803578

<https://www.phoenixcontact.com/in/products/1803578>

Dimensional drawing

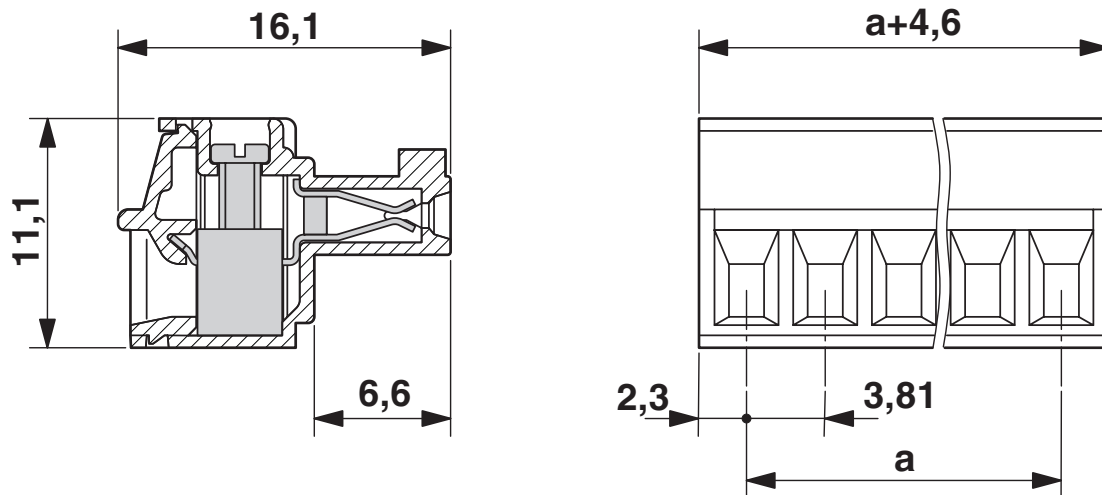

Diagram

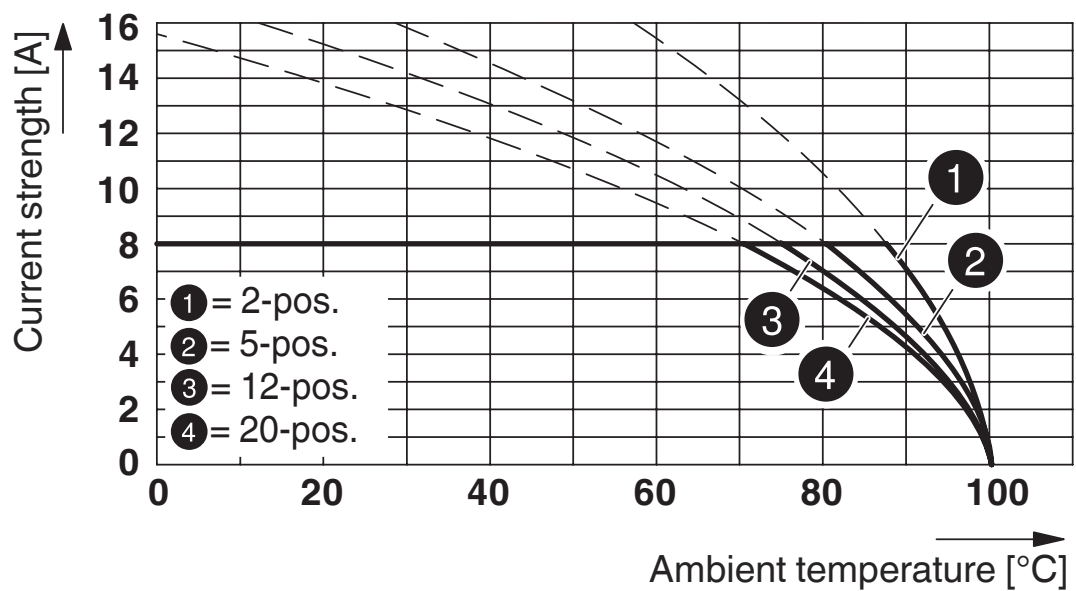

Type: MC 1,5/...-ST-3,81 with MC 1,5/...-G-3,81



# MC 1,5/ 2-ST-3,81 - PCB connector



1803578

<https://www.phoenixcontact.com/in/products/1803578>

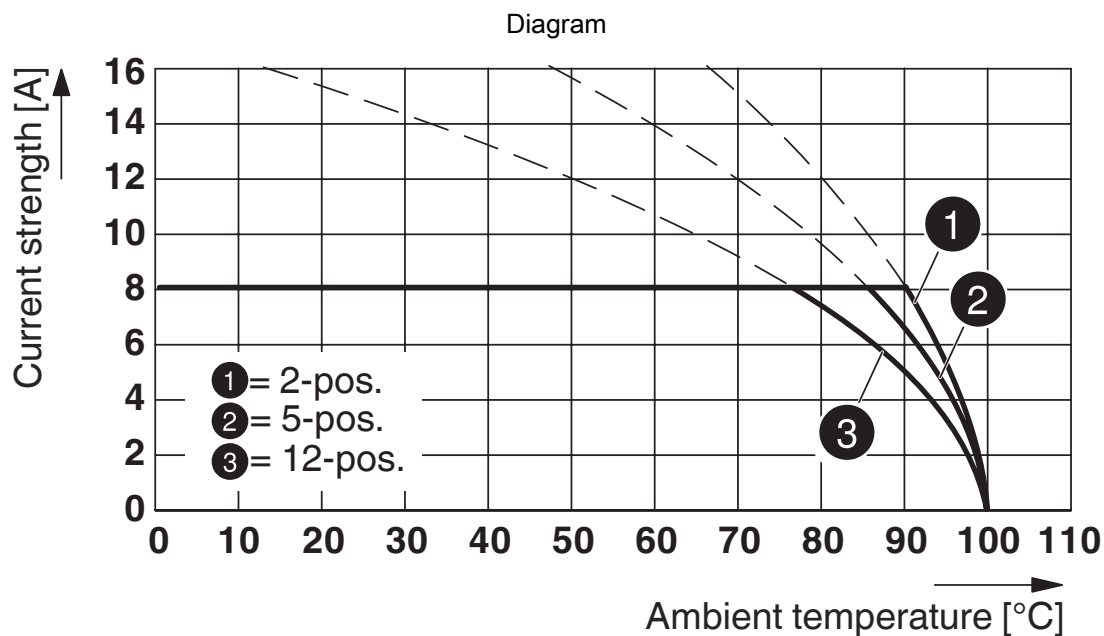

Type: MC 1,5/...-ST-3,81 with MCV 1,5/...-G-3,81 P26 THR

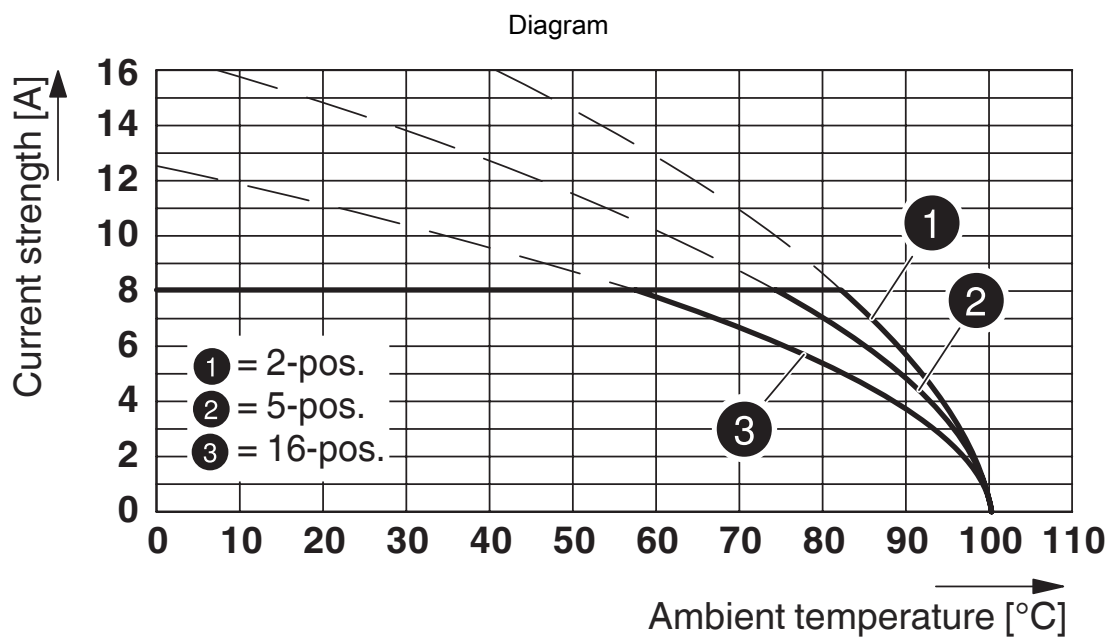

Type: MC 1,5/...-ST-3,81 with MCD 1,5/...-G1-3,81

# MC 1,5/ 2-ST-3,81 - PCB connector



1803578

<https://www.phoenixcontact.com/in/products/1803578>

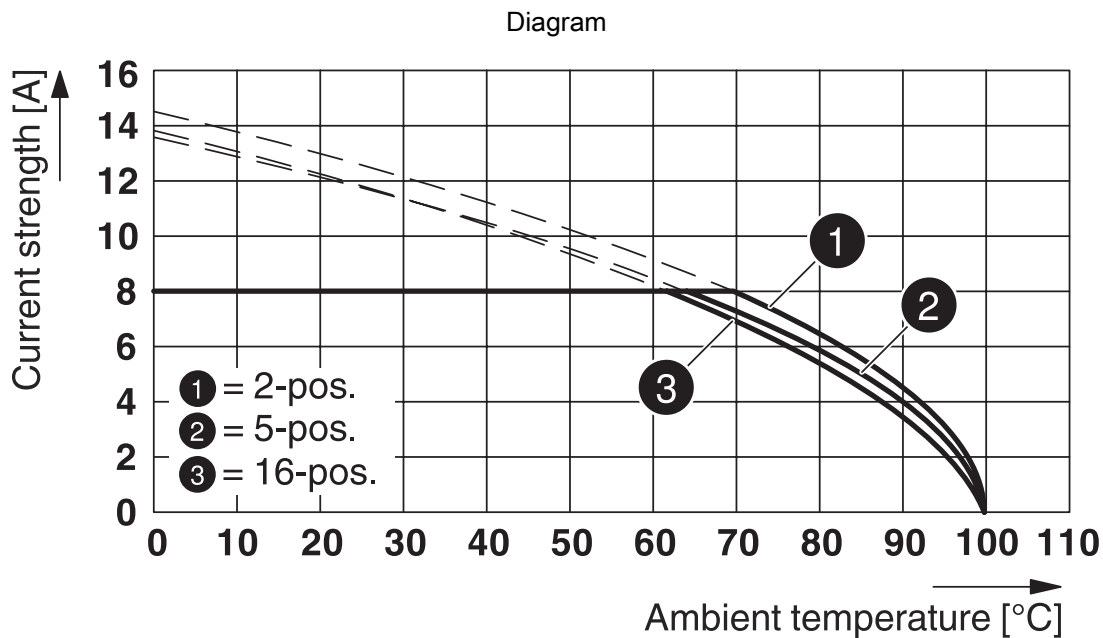

Type: MC 1,5/...-ST-3,81 with MCVU 1,5/...-GFD-3,81

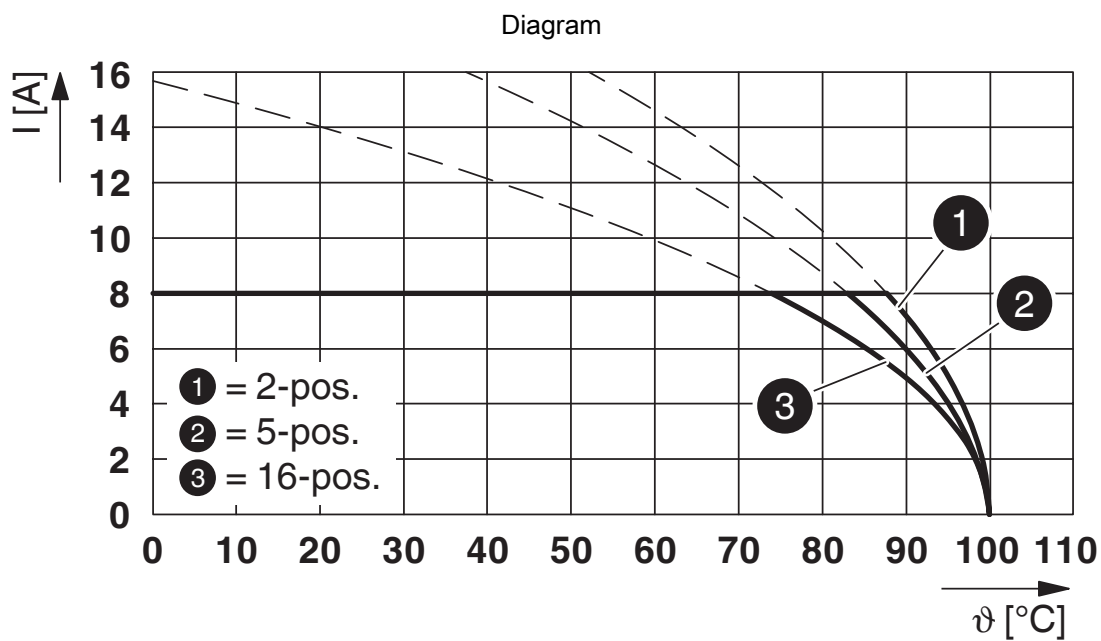

Type: MC 1,5/...-ST-3,81 with SMC 1,5/...-G-3,81

# MC 1,5/ 2-ST-3,81 - PCB connector



1803578

<https://www.phoenixcontact.com/in/products/1803578>

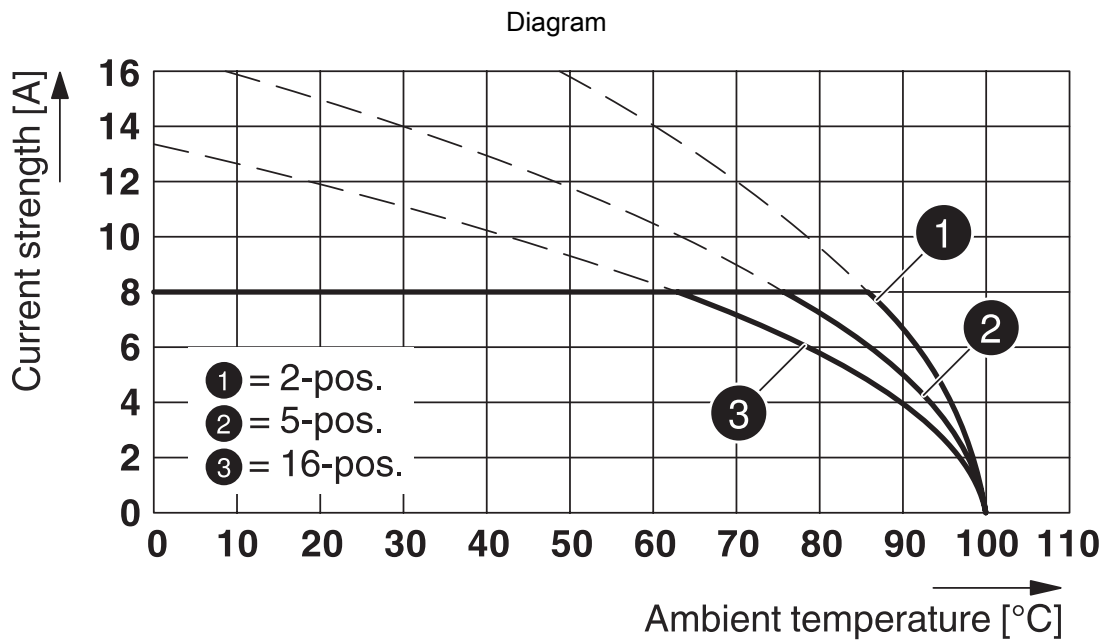

Type: MC 1,5/...-ST-3,81 with MCDV 1,5/...-G1-3,81

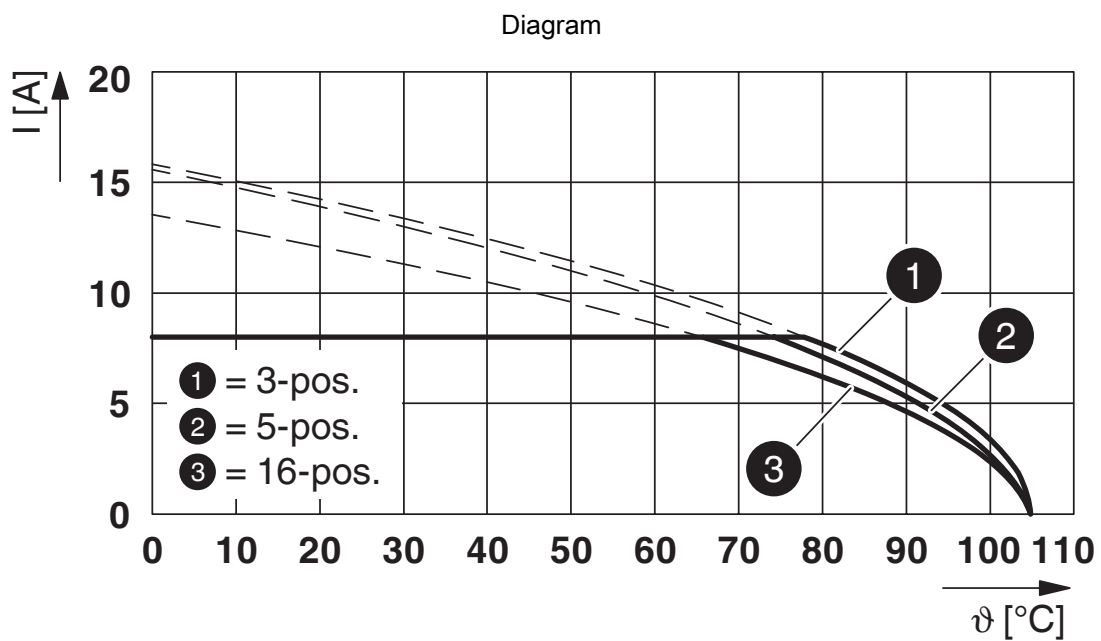

Type: MC 1,5/...-ST-3,81 with MCVK 1,5/...-G-3,81

# MC 1,5/ 2-ST-3,81 - PCB connector



1803578

<https://www.phoenixcontact.com/in/products/1803578>

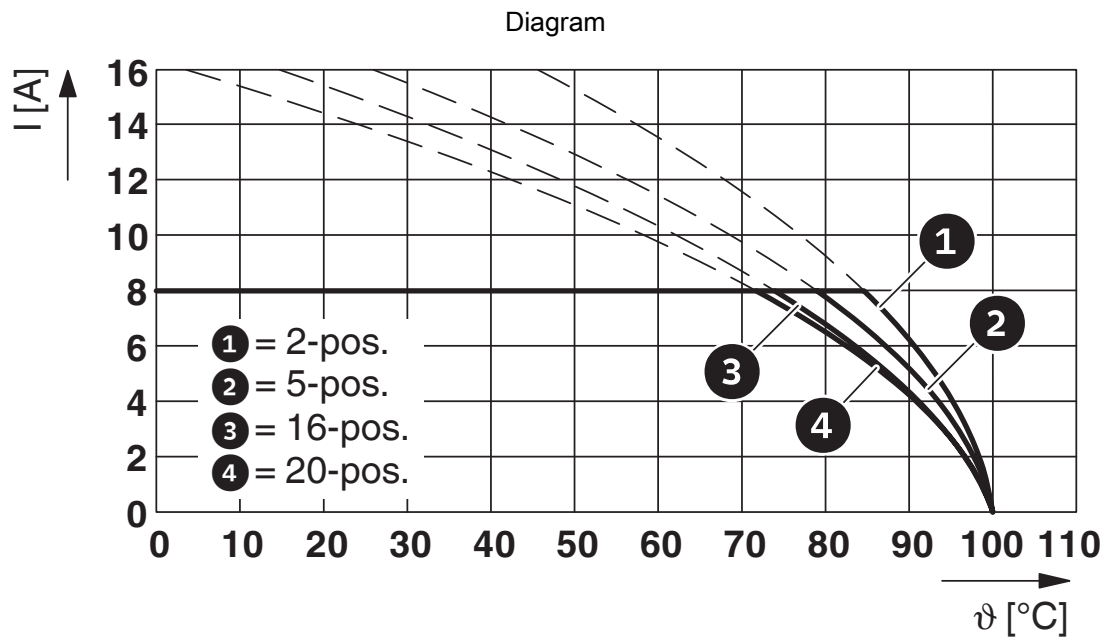

Type: MC 1,5/...-ST-3,81 with MC 1,5/...-G-3,81 P...THR

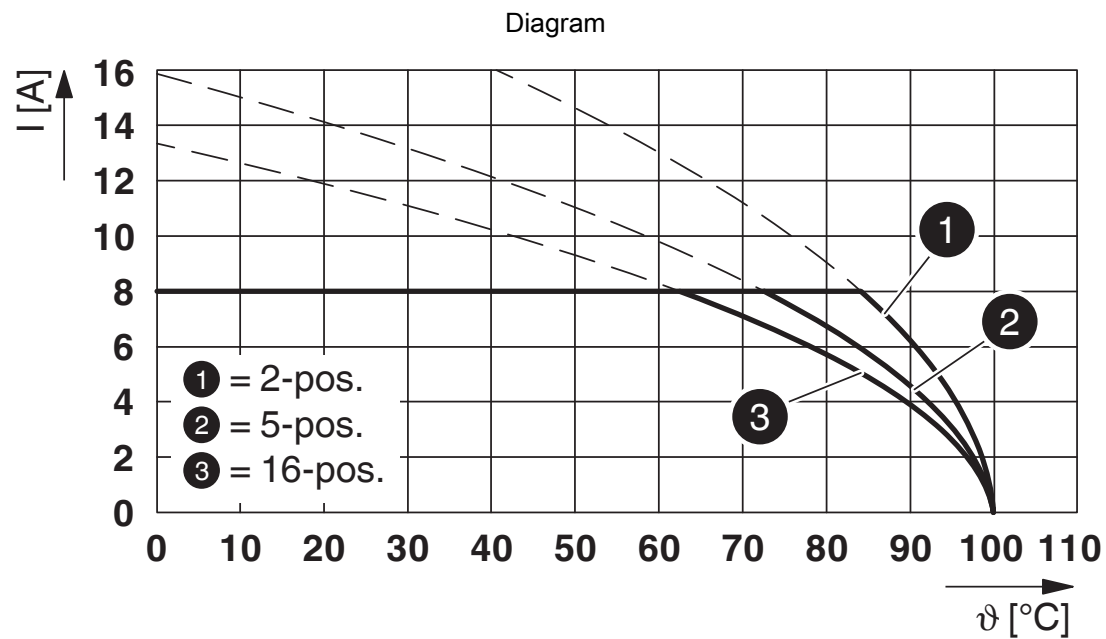

Type: MC 1,5/...-ST-3,81 with MCD 1,5/...-G-3,81

# MC 1,5/ 2-ST-3,81 - PCB connector



1803578

<https://www.phoenixcontact.com/in/products/1803578>

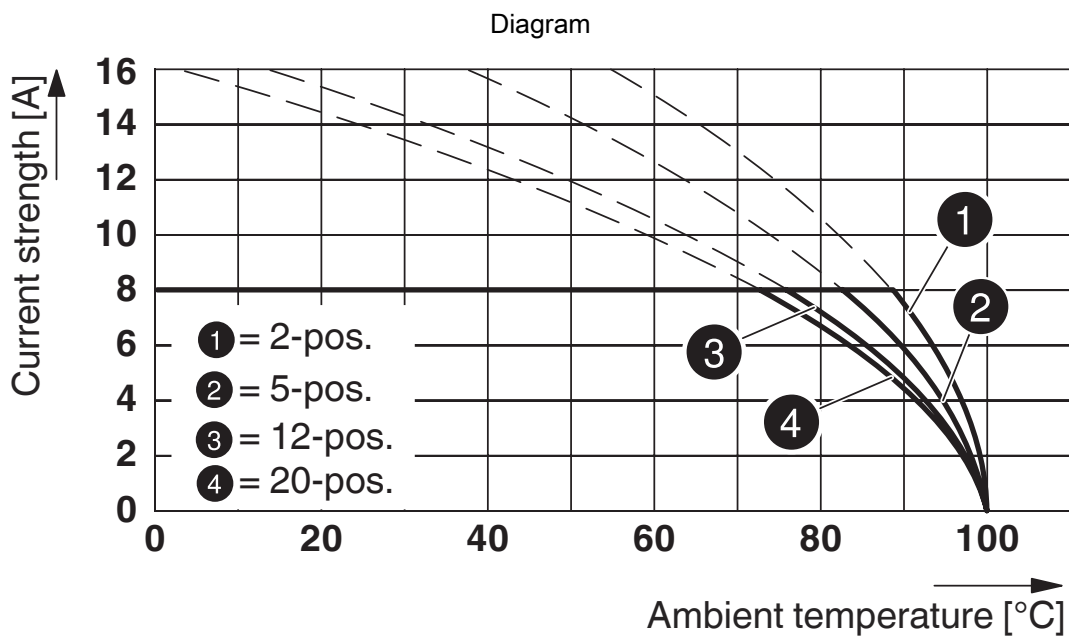

Type: MC 1,5/...-ST-3,81 with MCV 1,5/...-G-3,81

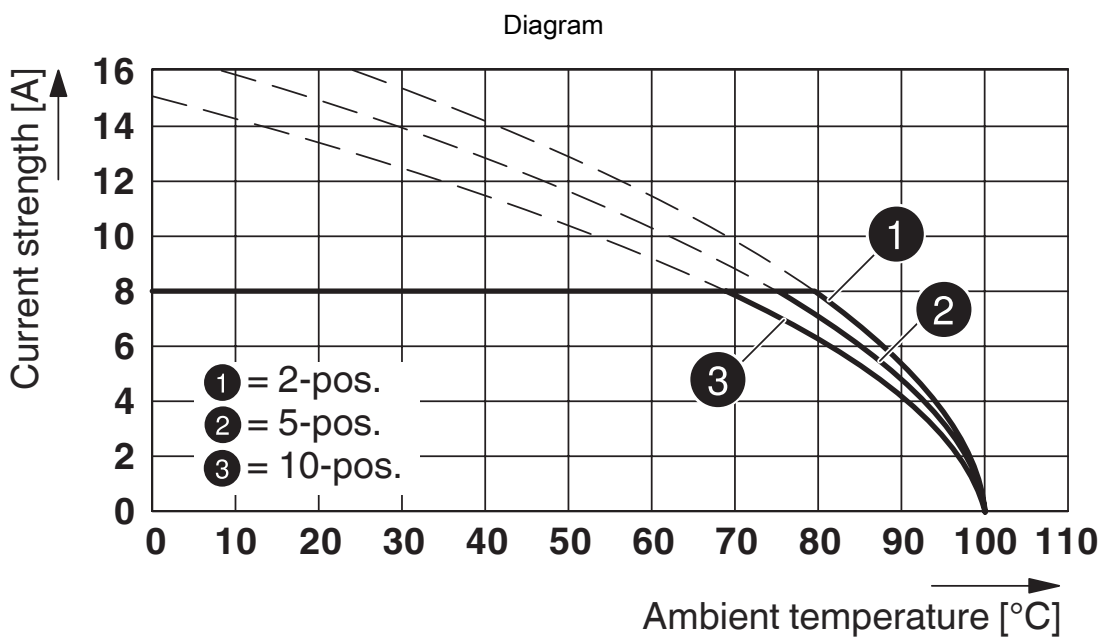

Type: MC 1,5/...-ST-3,81 with MCO 1,5/...-GR-3,81

# MC 1,5/ 2-ST-3,81 - PCB connector





1803578

<https://www.phoenixcontact.com/in/products/1803578>

## Approvals

To download certificates, visit the product detail page: <https://www.phoenixcontact.com/in/products/1803578>

 <b>CSA</b> Approval ID: 13631				
	Nominal voltage $U_N$	Nominal current $I_N$	Cross section AWG	Cross section $\text{mm}^2$
Use group B				
	300 V	8 A	28 - 16	-
Use group D				
	300 V	8 A	28 - 16	-

 <b>cULus Recognized</b> Approval ID: E60425-20110128				
	Nominal voltage $U_N$	Nominal current $I_N$	Cross section AWG	Cross section $\text{mm}^2$
Use group B				
	300 V	8 A	30 - 14	-
Use group D				
	300 V	8 A	30 - 14	-

 <b>VDE Zeichengenehmigung</b> Approval ID: 40011723				
	Nominal voltage $U_N$	Nominal current $I_N$	Cross section AWG	Cross section $\text{mm}^2$
	160 V	8 A	-	0.2 - 1.5

# MC 1,5/ 2-ST-3,81 - PCB connector



1803578

<https://www.phoenixcontact.com/in/products/1803578>

## Classifications

### ECLASS

ECLASS-11.0	27460202
ECLASS-12.0	27460202
ECLASS-13.0	27460202

### ETIM

ETIM 9.0	EC002638
----------	----------

### UNSPSC

UNSPSC 21.0	39121400
-------------	----------

# MC 1,5/ 2-ST-3,81 - PCB connector

1803578

<https://www.phoenixcontact.com/in/products/1803578>



## Environmental product compliance

China RoHS	Environmentally friendly use period: unlimited = EFUP-e
	No hazardous substances above threshold values



# MC 1,5/ 2-ST-3,81 - PCB connector

1803578

<https://www.phoenixcontact.com/in/products/1803578>



## Accessories

### SK 3,81/2,8:FORTL.ZAHLEN - Marker card

0804109

<https://www.phoenixcontact.com/in/products/0804109>

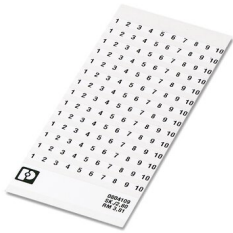

Marker card, white, labeled, horizontal: consecutive numbers 1 ... 10, 11 ... 20, etc. up to 91 ... (99)100, mounting type: adhesive, for terminal block width: 3.81 mm, lettering field size: 3.81 x 2.8 mm

---

### SZS 0,4X2,5 VDE - Screwdriver

1205037

<https://www.phoenixcontact.com/in/products/1205037>



Screwdriver, slot-headed, VDE insulated, size: 0.4 x 2.5 x 80 mm, 2-component grip, with non-slip grip

# MC 1,5/ 2-ST-3,81 - PCB connector

1803578

<https://www.phoenixcontact.com/in/products/1803578>



## KGG-MC 1,5/ 2 - Cable housing

1834343

<https://www.phoenixcontact.com/in/products/1834343>

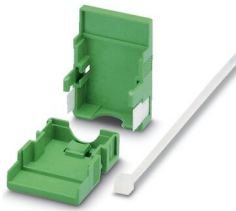

Cable housing, pitch: 3.81 mm, number of positions: 2, dimension a: 10.01 mm, color: green

---

## EBPL 2-3,81 - Insertion bridge

1733495

<https://www.phoenixcontact.com/in/products/1733495>



Insertion bridge for plugs featuring a screw connection with a 3.81 mm pitch

# MC 1,5/ 2-ST-3,81 - PCB connector



1803578

<https://www.phoenixcontact.com/in/products/1803578>

## MCV 1,5/ 2-G-3,81 P14 THR - PCB header

1707007

<https://www.phoenixcontact.com/in/products/1707007>

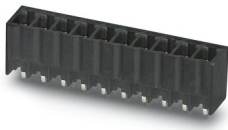

PCB headers, nominal cross section: 1.5 mm<sup>2</sup>, color: black, nominal current: 8 A, rated voltage (III/2): 160 V, contact surface: Tin, contact connection type: Pin, number of potentials: 2, number of rows: 1, number of positions: 2, number of connections: 2, product range: MCV 1,5/..-G-THR, pitch: 3.81 mm, mounting: THR soldering, pin layout: Linear pinning, solder pin [P]: 1.4 mm, number of solder pins per potential: 1, plug-in system: COMBICON MC 1,5, Pin connector pattern alignment: Standard, locking: without, mounting: without, type of packaging: packed in cardboard, For user information and design recommendations for through-hole reflow technology, go to: Downloads

## MCV 1,5/ 2-G-3,81 P26 THR - PCB header

1707421

<https://www.phoenixcontact.com/in/products/1707421>

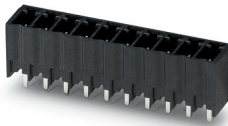

PCB headers, nominal cross section: 1.5 mm<sup>2</sup>, color: black, nominal current: 8 A, rated voltage (III/2): 160 V, contact surface: Tin, contact connection type: Pin, number of potentials: 2, number of rows: 1, number of positions: 2, number of connections: 2, product range: MCV 1,5/..-G-THR, pitch: 3.81 mm, mounting: THR soldering, pin layout: Linear pinning, solder pin [P]: 2.6 mm, number of solder pins per potential: 1, plug-in system: COMBICON MC 1,5, Pin connector pattern alignment: Standard, locking: without, mounting: without, type of packaging: packed in cardboard, For user information and design recommendations for through-hole reflow technology, go to: Downloads

Phoenix Contact 2023 © - all rights reserved  
<https://www.phoenixcontact.com>

PHOENIX CONTACT (I) Pvt. Ltd.  
A-58/2, Okhla Industrial Area, Phase - II, New Delhi-110 020

+91.1275.71420  
[info@phoenixcontact.co.in](mailto:info@phoenixcontact.co.in)